

电话：0755-83464948 传真：0755-83464076

# NAIS

## HE (High-function Economy) Type 1- Channel (Form B) Type

# PhotoMOS RELAYS

### FEATURES

#### 1. Form B (Normally-closed) type

Has been realized thanks to the built-in MOSFET processed by our proprietary method, DSD (Double-diffused and Selective Doping) method.

#### 4. Controls various types of load such as relays, motors, lamps and solenoids.

#### 5. Eliminates the need for a power supply to drive the power MOSFET

A power supply used to drive the power MOSFET is unnecessary because of the built-in optoelectronic device. This results in easy circuit design and small PC board area.

#### 6. Low thermal electromotive force (Approx. 1 μV) (Basic insulation)

#### 7. Reinforced insulation 5,000 V type also available.

More than 0.4 mm .016 inch internal insulation distance between inputs and outputs. Conforms to IEC950 (reinforced insulation).

#### 2. Controls low-level analog signals

PhotoMOS relays feature extremely low closed-circuit offset voltage to enable control of low-level analog signals without distortion.

#### 3. High sensitivity, low ON resistance

Can control a maximum 0.15 A load current with a 5 mA input current. Low ON resistance of 16 Ω (AQV454). Stable operation because there are no metallic contact parts.

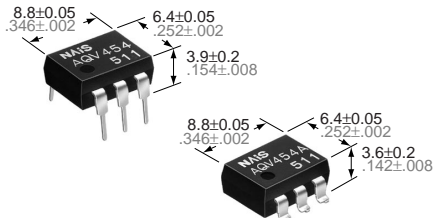
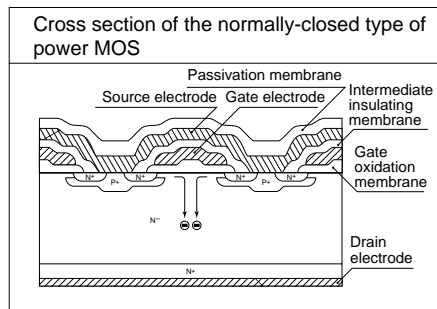

mm inch

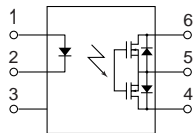

### TYPICAL APPLICATIONS

- Security equipment
- High-speed inspection machines
- Measuring instruments
- Telephone equipment
- Sensors

### TYPES

Type	I/O isolation	Output rating*		Part No.				Packing quantity	
		Load voltage	Load current	Through hole terminal	Surface-mount terminal			Tube	Tape and reel
				Tube packing style	Tape and reel packing style				
				Picked from the 1/2/3-pin side	Picked from the 4/5/6-pin side				
AC/DC	1,500 V AC	250 V	200 mA	AQV453	AQV453A	AQV453AX	AQV453AZ	1 tube contains 50 pcs. 1 batch contains 500 pcs.	1,000 pcs.
				AQV454	AQV454A	AQV454AX	AQV454AZ		
	Reinforced 5,000 V AC	400 V	150 mA	AQV454H	AQV454HA	AQV454HAX	AQV454HAZ		

\* Indicate the peak AC and DC values.

Note: For space reasons, the package type indicator "X" and "Z" are omitted from the seal.

# RATING

## 1. Absolute maximum ratings (Ambient temperature: 25°C 77°F)

Item		Symbol	Type of connection	AQV453(A)	AQV454(A)	AQV454H(A)	Remarks	
Input	LED forward current	$I_F$		50 mA			f = 100 Hz, Duty factor = 0.1%	
	LED reverse voltage	$V_R$		3 V				
	Peak forward current	$I_{FP}$		1 A				
	Power dissipation	$P_{in}$		75 mW				
Output	Load voltage (peak AC)	$V_L$		250 V	400 V		A connection: Peak AC, DC B,C connection: DC	
	Continuous load current	$I_L$		A	0.2 A	0.15 A		
				B	0.3 A	0.18 A		
				C	0.4 A	0.25 A		
	Peak load current	$I_{PEAK}$			0.6 A	0.5 A		A connection: 100 ms (1 shot), $V_L = DC$
Power dissipation	$P_{OUT}$		360 mW					
Total power dissipation		$P_T$		410 mW				
I/O isolation voltage		$V_{iso}$		1,500 V AC		5,000 V AC		
Temperature limits	Operating	$T_{opr}$		-40°C to +85°C -40°F to +185°F			Non-condensing at low temperatures	
	Storage	$T_{stg}$		-40°C to +100°C -40°F to +212°F				

## 2. Electrical characteristics (Ambient temperature: 25°C 77°F)

Item		Symbol	Type of connection	AQV453(A)	AQV454(A)	AQV454H(A)	Remarks		
Input	LED operate (OFF) current	Typical	$I_{Foff}$	—	1 mA	0.9 mA	1.4 mA	$I_L = Max.$	
		Maximum			3 mA				
	LED reverse (ON) current	Minimum	$I_{Fon}$	—	0.4 mA			$I_L = Max.$	
		Typical			0.9 mA	0.8 mA	1.3 mA		
LED dropout voltage	Typical	$V_F$	—	1.14 V (1.25V at $I_F=50$ mA)			$I_F = 5$ mA		
	Maximum			1.5 V					
Output	On resistance	Typical	$R_{on}$	A	5.5 Ω	10.5 Ω	10.5 Ω	$I_F = 0$ mA $I_L = Max.$ Within 1 s on time	
		Maximum			8 Ω	16 Ω	16 Ω		
		Typical	$R_{on}$	B	2.7 Ω	6.3 Ω	6.3 Ω	$I_F = 0$ mA $I_L = Max.$ Within 1 s on time	
		Maximum			4 Ω	8 Ω	8 Ω		
	Typical	$R_{on}$	C	1.4 Ω	3.1 Ω	3.1 Ω	$I_F = 0$ mA $I_L = Max.$ Within 1 s on time		
	Maximum			2 Ω	4 Ω	4 Ω			
Off state leakage current	Maximum	$I_{Leak}$	—	1 μA	10 μA	10 μA	$I_F = 5$ mA $V_L = Max.$		
Transfer characteristics	Switching speed	Operate (OFF) time*	Typical	$T_{off}$	—	1.52 ms	1.2 ms	1.8 ms	$I_F = 0$ mA → 5 mA $I_L = Max.$
			Maximum			3 ms	2.0 ms	3.0 ms	
		Reverse (ON) time*	Typical	$T_{on}$	—	0.4 ms	0.36 ms	0.4 ms	$I_F = 5$ mA → 0 mA $I_L = Max.$
			Maximum			1 ms	1.0 ms	1.0 ms	
	I/O capacitance		Typical	$C_{iso}$	—	1.3 pF			f = 1 MHz $V_B = 0$
		Maximum	3 pF						
Initial I/O isolation resistance		Minimum	$R_{iso}$	—	1,000 MΩ			500 V DC	

Note: Recommendable LED forward current.

Standard type:  $I_F = 5$  mA

Reinforced type:  $I_F = 5$  to 10 mA

\*Operate/Reverse time

For type of connection, see Page 32.

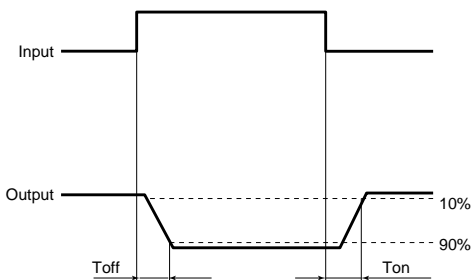

■ For Dimensions, see Page 27.

■ For Schematic and Wiring Diagrams, see Page 32.

■ For Cautions for Use, see Page 36.

## REFERENCE DATA

### 1. Load current vs. ambient temperature characteristics

Allowable ambient temperature:  $-40^{\circ}\text{C}$  to  $+85^{\circ}\text{C}$   
 $-40^{\circ}\text{F}$  to  $+185^{\circ}\text{F}$

Type of connection: A

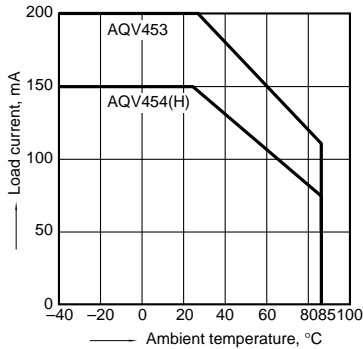

### 2. On resistance vs. ambient temperature characteristics

Measured portion: between terminals 4 and 6;  
 LED current: 0 mA; Load voltage: Max. (DC);  
 Continuous load current: Max. (DC)

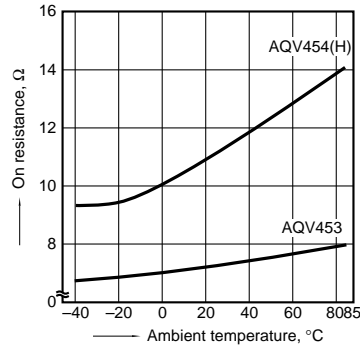

### 3. Operate (OFF) time vs. ambient temperature characteristics

LED current: 5 mA; Load voltage: Max. (DC);  
 Continuous load current: Max. (DC)

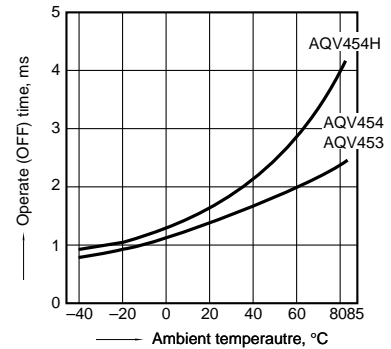

### 4. Reverse (ON) time vs. ambient temperature characteristics

LED current: 5 mA; Load voltage: Max. (DC);  
 Continuous load current: Max. (DC)

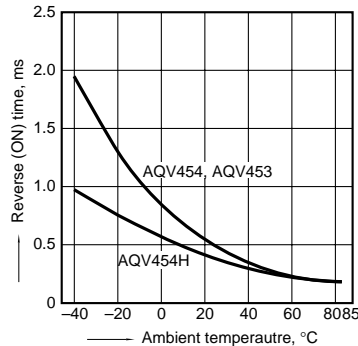

### 5. LED operate (OFF) current vs. ambient temperature characteristics

Load voltage: Max. (DC);  
 Continuous load current: Max. (DC)

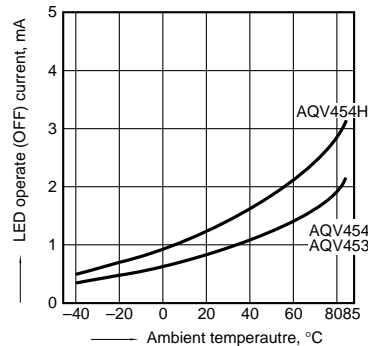

### 6. LED reverse (ON) current vs. ambient temperature characteristics

Load voltage: Max. (DC);  
 Continuous load current: Max. (DC)

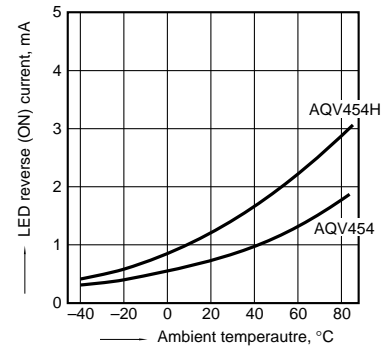

### 7. LED dropout voltage vs. ambient temperature characteristics

LED current: 5 to 50 mA

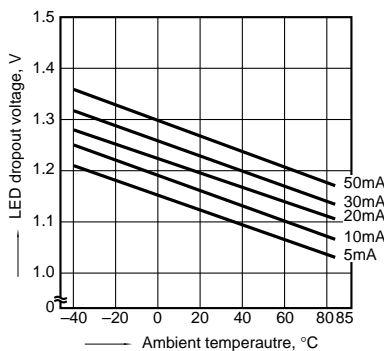

### 8. Voltage vs. current characteristics of output at MOS portion

Measured portion: between terminals 4 and 6;  
 Ambient temperature:  $25^{\circ}\text{C}$   $77^{\circ}\text{F}$

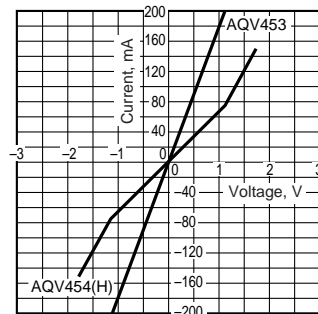

### 9. Off state leakage current

Sample: AQV454;  
 Measured portion: between terminals 4 and 6;  
 Ambient temperature:  $25^{\circ}\text{C}$   $77^{\circ}\text{F}$

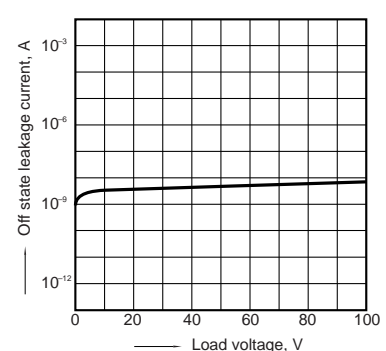

### 10. LED forward current vs. operate (OFF) time characteristics

Measured portion: between terminals 4 and 6;  
 Load voltage: Max. (DC); Continuous load current:  
 Max. (DC); Ambient temperature:  $25^{\circ}\text{C}$   $77^{\circ}\text{F}$

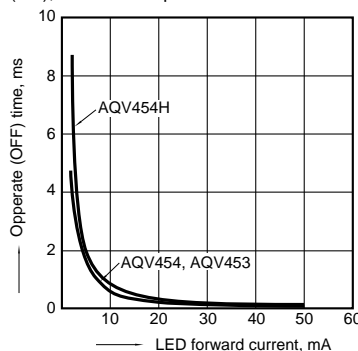

### 11. LED forward current vs. reverse (ON) time characteristics

Measured portion: between terminals 4 and 6;  
 Load voltage: Max. (DC); Continuous load current:  
 Max. (DC); Ambient temperature:  $25^{\circ}\text{C}$   $77^{\circ}\text{F}$

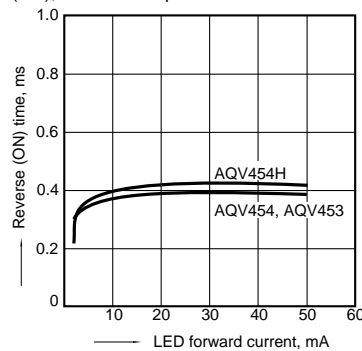

### 12. Applied voltage vs. output capacitance characteristics

Measured portion: between terminals 4 and 6;  
 Frequency: 1 MHz; Ambient temperature:  $25^{\circ}\text{C}$   $77^{\circ}\text{F}$

