

Features and Benefits

- The control circuit and RGB chip are integrated in a 5050 components, to form an external control pixel.
- Intelligent Reverse-connection protection.
- Using the built-in signal reshaping circuit to achieve the signal waveform shaping, and no distortion of waveform of signal takes place.
- The gray levels of each pixel are of 256 levels, which achieves “256*256*256=16777216” full-color display, and the refresh frequency reaches to 2KHz.
- Serial cascade interface, data receiving and decoding depend on just one signal line.
- Dual-signal wires version, signal break-point continuous transmission.
- Any two point the distance more than 5M transmission signal without any increase circuit.
- When the refresh rate is 30fps, cascade numbers is at least 1024 pixels.
- Data transmitting at speeds of up to 800Kbps.
- Good color consistency reliability, high cost-effective.

Applications

- Guardrail tube series, point light display series, flexible/rigid strips series, module series applications.
- Lighting stage costumes, innovative gadgets or any other electronic products.

General description

WS2813 is an intelligent control LED light source that the control circuit and RGB chip are integrated in a package of 5050 components. Its internal include intelligent digital port data latch and signal reshaping amplification drive circuit. Also include a precision internal oscillator and a 12V voltage programmable constant current control part, which achieves highly consistent color effect.

Dual-signal wires version, signal break-point continuous transmission. Any pixel's failure won't affect signal transfer and total emitting effect.

The data transfer protocol use single NZR communication mode. After the pixel power-on reset, the DIN port receive data from controller, the first pixel collect initial 24bit data then sent to the internal data latch, the other data which reshaping by the internal signal reshaping amplification circuit sent to the next cascade pixel through the DO port. After transmission for each pixel, the signal to reduce 24bit. Every pixel adopts auto-reshaping transmit technology, making the pixel cascade numbers are not limited to the signal transmission, only relate to the speed of signal transmission.

The BIN receives the data signal, and then compare the data with the DIN side after phagocytosis of 24bit data, if DIN do NOT receive the signal, then switching to BIN for receiving the input signal, which ensure that any the IC's damage does not affect the signal cascade transmission and make the BIN in state of receiving signal until restart after power-off.

Refresh Frequency updates to **2KHz**, Low Frame Frequency and no Flicker appear in HD Video Camera.

RESET time>**280μs**, it won't cause wrong reset while interruption, it supports the lower frequency and inexpensive MCU.

Integrated circuit chips enable the circuit control simpler, neater and more reliable while NO extra components needed.

There's in a choice of 16mA or 5mA current version, and also in a choice of high brightness or cost-effective version. That is to say, WS2813 is provided with four versions.

Mechanical Dimensions

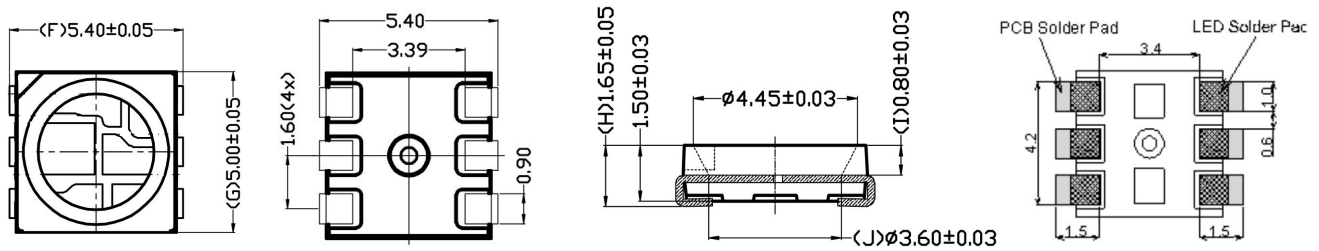

◆ Remarks

1. Dimension: 5.0*5.4*1.5mm
2. Default tolerance: ± 0.01 mm

PIN Configuration

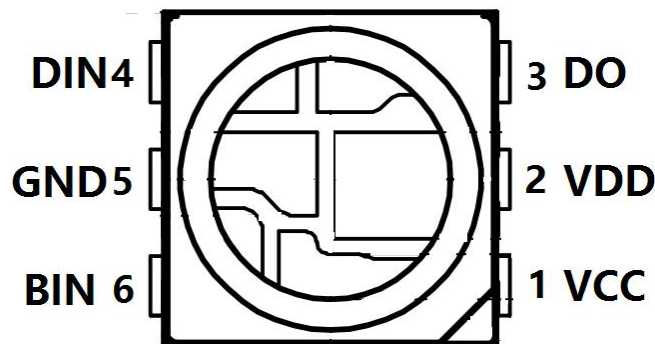

PIN Function

NO.	Symbol	PIN	Function description
1	VCC	VCC	IC POWER SUPPLY
2	VDD	VDD	LED POWER SUPPLY, connect to "+5V"
3	DO	DO	Control data signal output
4	DIN	DIN	Control data signal input
5	GND	GND	Data & Power Grounding
6	BIN	BIN	Backup Control data signal input

Absolute Maximum Ratings

Parameter	Symbol	Ratings	Unit
Power supply voltage	V_{DD}	+3.7~+5.3	V
Logical Input Voltage	V_I	$V_{DD}-0.7 \sim V_{DD}+0.7$	V
Operating Temperature	T_{opt}	-25~+85	°C
Storage Temperature	T_{stg}	-40~+105	°C

Electrical Characteristics (TA=-20~+70°C, VDD=4.5~5.5V, VSS=0V)

Parameter	Symbol	Min.	Tpy.	Max.	Unit	Conditions
Input Current	I _I	---	---	±1	μA	V _I =VDD/VSS
High-level Input	V _{IH}	0.7VDD	---	---	V	D _{IN} , SET
Low-level Input	V _{IL}	---	---	0.3 VDD	V	D _{IN} , SET
Hysteresis voltage	V _H	---	0.35	---	V	D _{IN} , SET

Switching Characteristics (TA=-20~+70°C, VDD=4.5~5.5V, VSS=0V)

Parameter	Symbol	Min	Tpy	Max	Unit	Condition
Transmission Delay Time	T _{PLZ}	---	---	300	ns	CL=15pF, DIN→DOUT, RL=10KΩ
Fall time	T _{THZ}	---	---	120	μs	CL=300pF, OUTF/OUTG/OUTB
Input-capacitance	C _I	---	---	15	pF	---

LED Characteristics

	WS2813A	WS2813B	WS2813C	WS2813D
Quiescent Current	0.7mA	0.7mA	0.3mA	0.3mA
RGB Channel Constant Current	16mA	16mA	5mA	5mA
RED Brightness (Central Value)	480mcd	360mcd	60mcd	100mcd
GREEN Brightness (Central Value)	1500mcd	1150mcd	245mcd	420mcd
BLUE Brightness (Central Value)	320mcd	220mcd	60mcd	110mcd
WHITE Brightness (Central Value)	2300mcd	1710mcd	320-410mcd	630mcd
RED Wavelength	620-625nm	620-625nm	620-625nm	620-625nm
GREEN Wavelength	515-525nm	515-525nm	515-525nm	515-525nm
BLUE Wavelength	465-475nm	465-475nm	465-475nm	465-475nm

Data Transfer Time

T0H	0-code, High-level time	220ns~380ns
T1H	1-code, High-level time	580ns~1.6μs
T0L	0-code, Low-level time	580ns~1.6μs
T1L	1-code, Low-level time	220ns~420ns
RES	Frame unit, Low-level time	> 280μs

Sequence chart

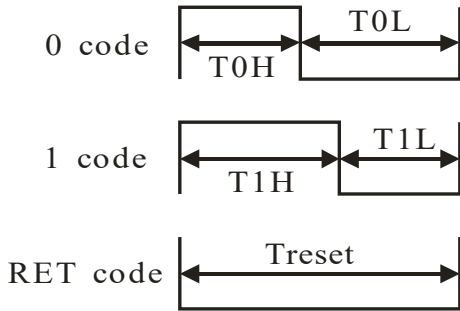

Cascade method

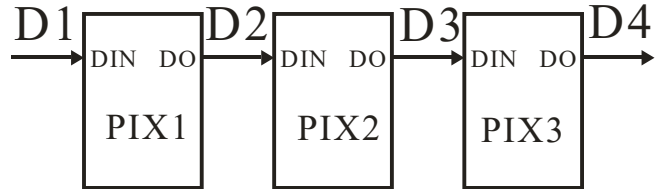

Data Transmission Method

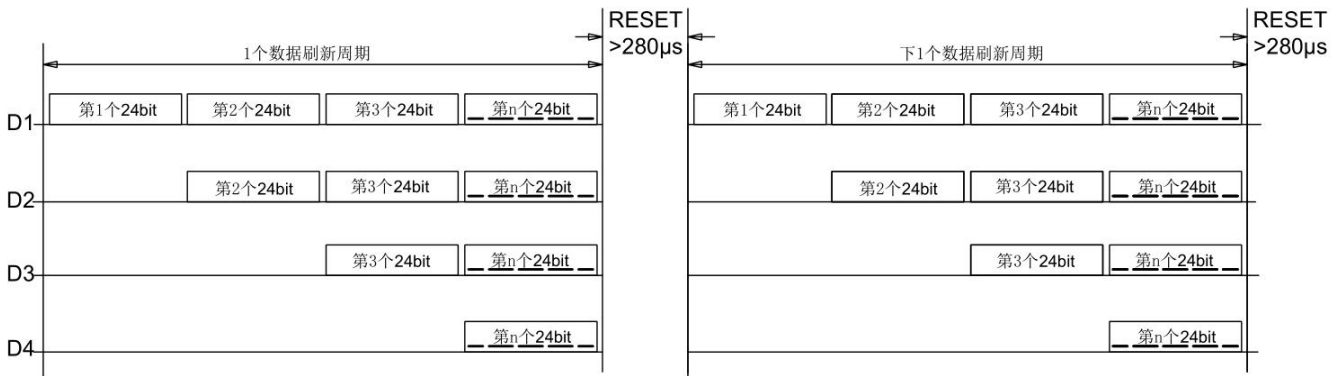

Note: D1 is the data from MCU, and D2, D3, D4 are from Cascade Circuits.

Composition of 24bit data

G7	G6	G5	G4	G3	G2	G1	G0	R7	R6	R5	R4	R3	R2	R1	R0	B7	B6	B5	B4	B3	B2	B1	B0
----	----	----	----	----	----	----	----	----	----	----	----	----	----	----	----	----	----	----	----	----	----	----	----

Note: Data transmit in order of GRB, high bit data is first.

Typical application circuit

1. Recommended application circuit

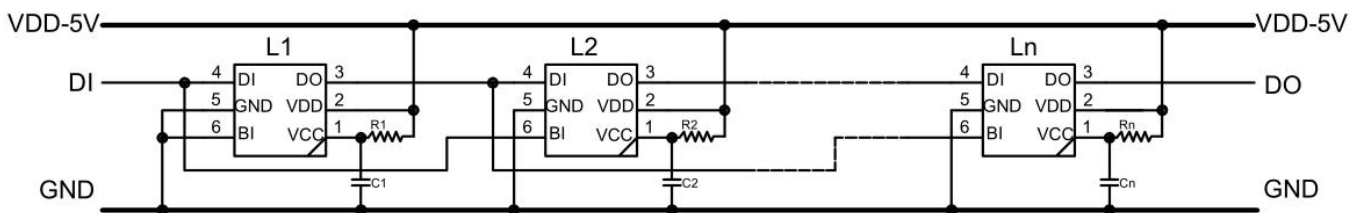

Remarks: R1 is the IC's protective resistance, power spike and reverse connection of the battery power terminal, will be protected, its range of 150R~390R. C1 is external filter capacitor, its value of 100NF.

2. For complicated wiring & space-saving

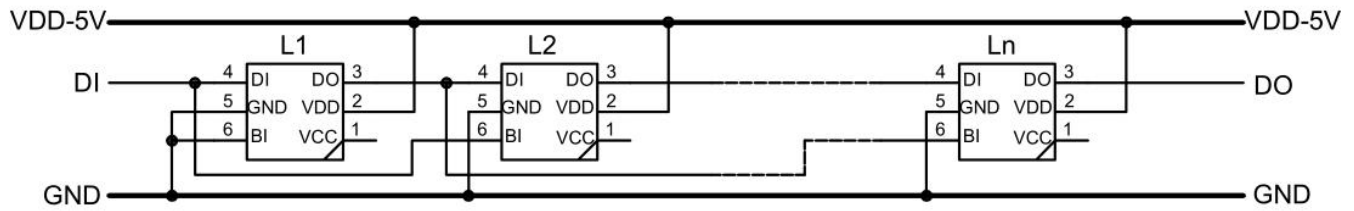

Packing Standard

Packing: 1K/Reel: 167*12mm
4.5K/Reel: 327*12mm

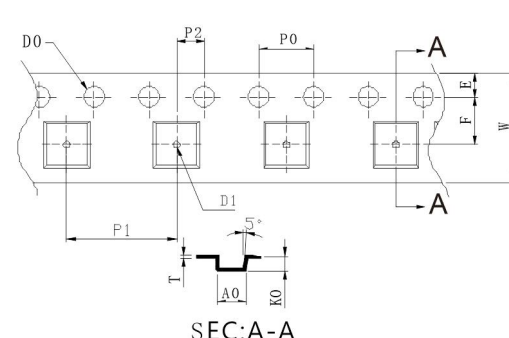

SEC:A-A

Carrier tape	
SYMBOL	SPEC.
W	12.00±0.20
T	0.25±0.02
A0	5.35±0.10
B0	5.75±0.10
K0	1.85±0.10
E	1.75±0.10
F	5.50±0.10
D0	1.60±0.10
D1	1.60±0.10
P1	8.00±0.10
P2	2.00±0.05
10*P0	40.00±0.20

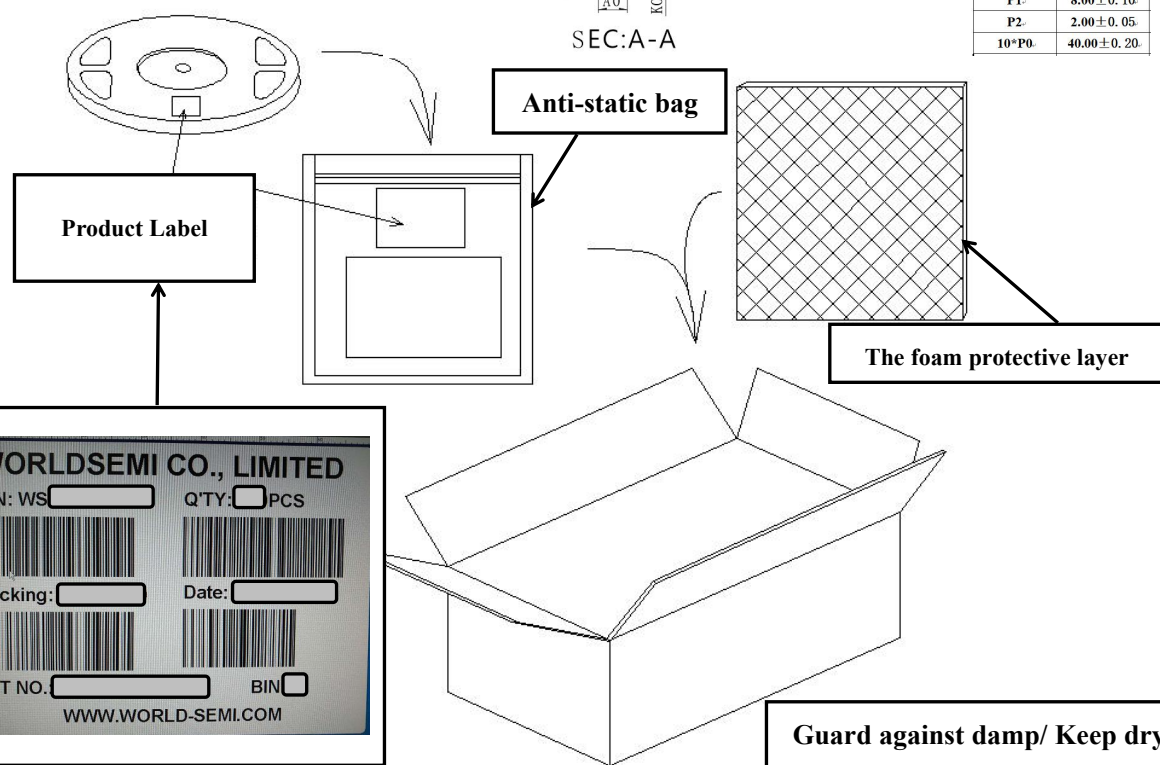

Anti-static bag

The foam protective layer

Guard against damp/ Keep dry

Product Label

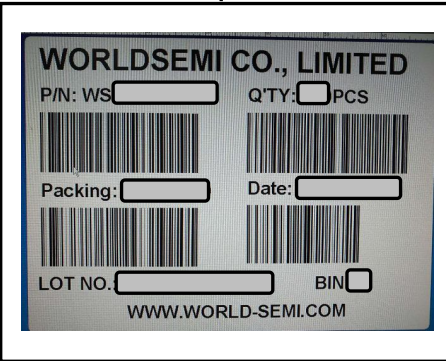

WORLDSEMI CO., LIMITED
P/N: WS Q'TY: PCS
Packing: Date:
LOT NO. BIN
WWW.WORLD-SEMI.COM

Top SMD LED Using Instructions

1. Summary

To make the best use of WORLDSEMI's LED, please refer to the below precautions, they are of same usage method as other electronic components.

2. Cautions

2.1. Dust & Cleaning

The surface of the LED is encapsulated with modified epoxy resin because it plays a very good role in protecting the optical performance and aging resistance. The modified epoxy resin is easy to stick with dust and must be kept clean. When there's a certain amount of dust on the surface of the LED, it won't affect brightness, but dust proof should be taken care of. Promoting the use of unsealed package in preference to others and the assembled LEDs should be placed in a clean container.

Avoid using the organic solvents to clean the dust on the LED surface and it's necessary to confirm whether the cleaning fluid will dissolve the LED.

Do not clean the LEDs by the ultrasonic. Some parameters affecting the LED performance must be evaluated if have no alternative but to the ultrasonic cleaning method, such as ultrasonic power, baking time and assembly conditions, etc.

2.2. Moisture-proof packaging

TOP SMD LEDs are moisture sensitive components. LEDs are packaged in aluminum foil bag to prevent the from absorbing moisture during transport and storage. A desiccant is placed in the bags to absorb moisture. If the LED absorbs moisture, then it evaporates and expands when in reflow process, which may break the colloid from the bracket and damage the optical performance of LED. For this reason, moisture-proof packaging is to prevent the from absorbing moisture during transport and storage. The moisture resistance rating of WORLDSEMI's LED is: **LEVEL 6.**

Table I - IPC/JEDEC J-STD-020 Moisture/Reflow Sensitivity Classification

MSL Level	Workshop Life	
	Time	Conditions
LEVEL1	Unlimited	≤30°C/85%RH
LEVEL2	1 Year	≤30°C/60%RH
LEVEL2a	4 Weeks	≤30°C/60%RH
LEVEL3	168 Hours	≤30°C/60%RH
LEVEL4	72 Hours	≤30°C/60%RH
LEVEL5	48 Hours	≤30°C/60%RH
LEVEL5a	24 Hours	≤30°C/60%RH
LEVEL6	Take-out and Use immediately	≤30°C/60%RH

2.3. Management after unpacking

It's recommend to perform SMT assembly as soon as possible after opening the moisture-proof bag, and reflow soldering should be completed within 4 hours after SMT assembly; for the remaining LEDs, they should be re-packed in seal package and placed in moisture-proof cabinet (Please note that it's necessary to rebake at "70°C-75°C/48 hours" before next SMT process).

3. Dehumidification Operation (Non-leakage of air, baking temperature:70°C-75°C)

- a. MD within 2 weeks, baking time: 24 hours.
- b. MD exceeds 2 weeks, baking time: 48 hours.

4. Management of secondary SMT process

It's necessary to do moisture-proof treatment when the secondary reflow carried out that followed the first reflow. It can't be more than 2 hours to be exposed at condition of "<30°C/60%RH" and dehumidification operation is requested for a longer interval reflow. For instance, place in a drying box or a container with desiccant, and dehumidify it before the secondary reflow(Low temperature baking operation: 70°C-75°C, ≥12 hours).

5. SMT Reflow

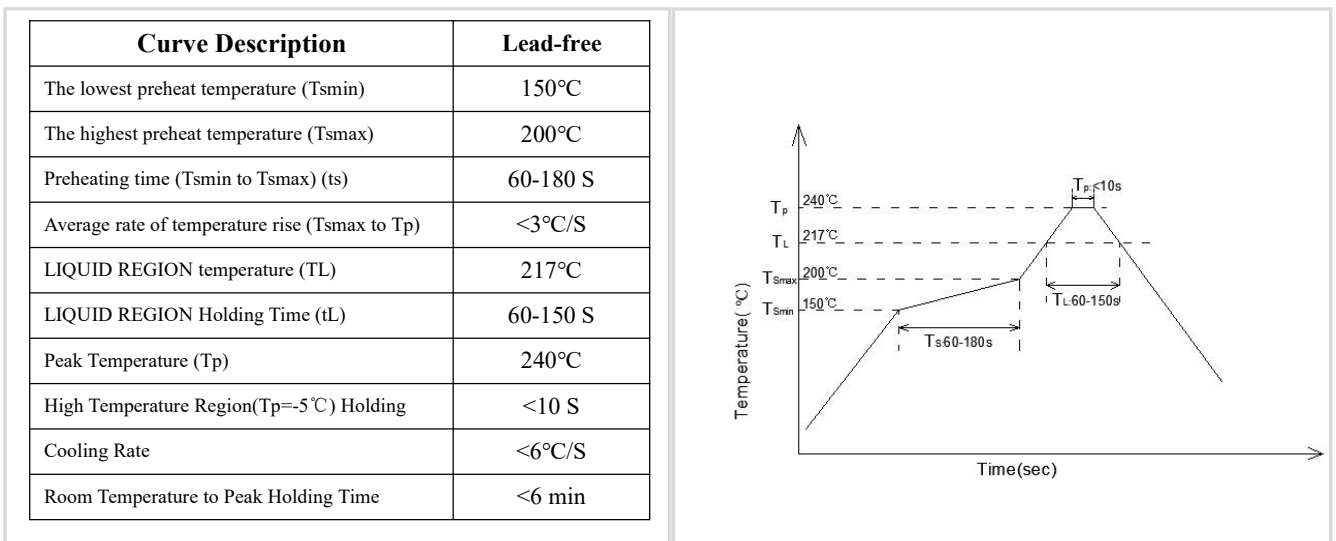

Refer to the parameters listed below, the experimental results prove that the TOP SMD LED meets the JEDEC J-STD-020C standards. As a general guideline, it is recommended to follow the SMT reflow temperature curve recommended by the solder paste manufacturer.



Remarks: 1. These general guidelines may not apply to all PCB designs and reflow soldering configurations.

2. All temperatures referred are measured on the surface of the package body.

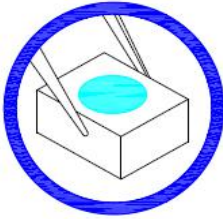
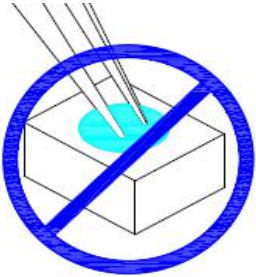
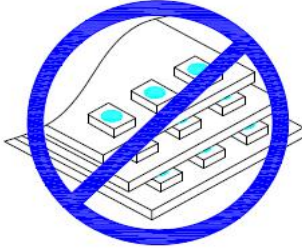
6. Assembly Precautions

1. Clip the LED from its side.	2. Neither directly touch the gel surface with the hand or sharp instrument, it may damage its internal circuit.
	
3. Not to be double stacked, it may damage its internal circuit.	4. Can not be stored in or applied in the acidic sites of PH<7.
	

Modify Record

Version №	Status Bar	Modify Content Summary	Date	Reviser	Approved
V1.0	N	New	20170523	Shen JinGuo	Yin HuaPing
V1.1	M	Absolute Maximum Ratings、 Mechanical Dimensions	20171009	Shen JinGuo	Yin HuaPing
V1.2	M	Maximum ratings, Timing	20180207	Shen JinGuo	Yin HuaPing
V1.3	M	“The transparent sealing silica gel” changed to “The opaque Modified Epoxy Resin”. Refers to PRECAUTIONS	20180412	Shen JinGuo	Yin HuaPing
V1.4	M	Logical Input Voltage; Brightness adjustment; Precautions	20180719	Shen JinGuo	Yin HuaPing

Remarks: Initial version: V1.0; Version number plus "0.1" after each revision;

Status bar: N--New, A--Add, M--Modify, D--Delete.